

SUPORTES TRF001 E TERMINAIS INTERMEDIÁRIO E FINAL NO MESMO POSICIONAMENTO

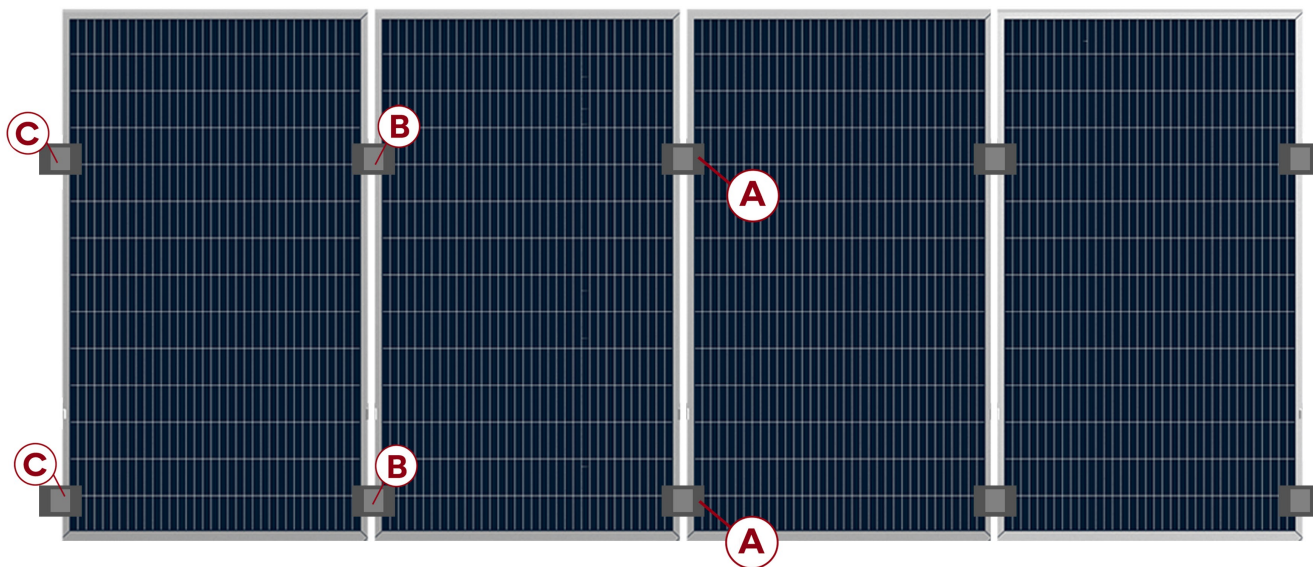

SUPORTE

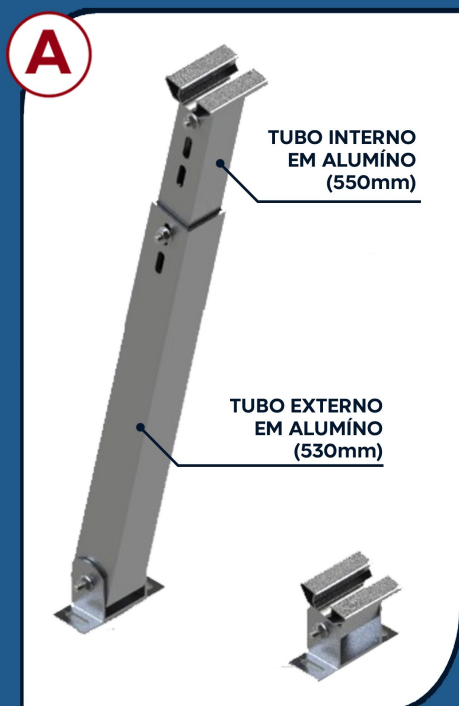

TRF001
SUPORTE METÁLICO ALUMÍNIO
VERTICAL - CORREÇÃO DE INCLINAÇÃO
5 UNIDADES

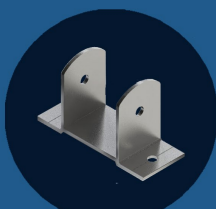

BASE
(115x65x45mm)
10 UNIDADES

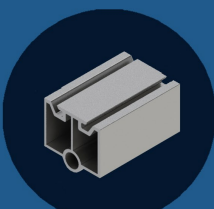

TERMINAL
ARTICULADO
INFERIOR
(38x27,5x54mm)
5 UNIDADES

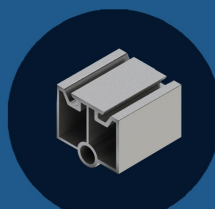

TERMINAL
ARTICULADO
SUPERIOR
(38x27,5x38mm)
5 UNIDADES

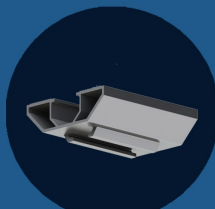

TERM. DE INCLINAÇÃO
INFERIOR
(38x30x80mm)
5 UNIDADES

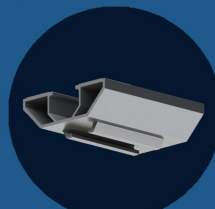

TERM. DE INCLINAÇÃO
SUPERIOR
(38x30x80mm)
5 UNIDADES



CONJ ALLEN
M8x60
5 UNIDADES



CONJ ALLEN
M8x70
5 UNIDADES



CONJ ALLEN
M8x80
10 UNIDADES

ACESSÓRIOS



TI001
Terminal
Intermediário
6 UNIDADES



TF001
Terminal Final
4 UNIDADES